

# 3D SLOPE STABILITY ANALYSES OF A ZONED EARTH FILL DAM

by Ian Brown D.Eng, CPEng

November 17, 2016

## 1. Background

To assist with the design of an earth fill dam to be used for farm irrigation purposes, we have built a model of the proposed structure using the 3D modelling package Leapfrog®. An image showing the dam before impoundment is shown in Figure 1.

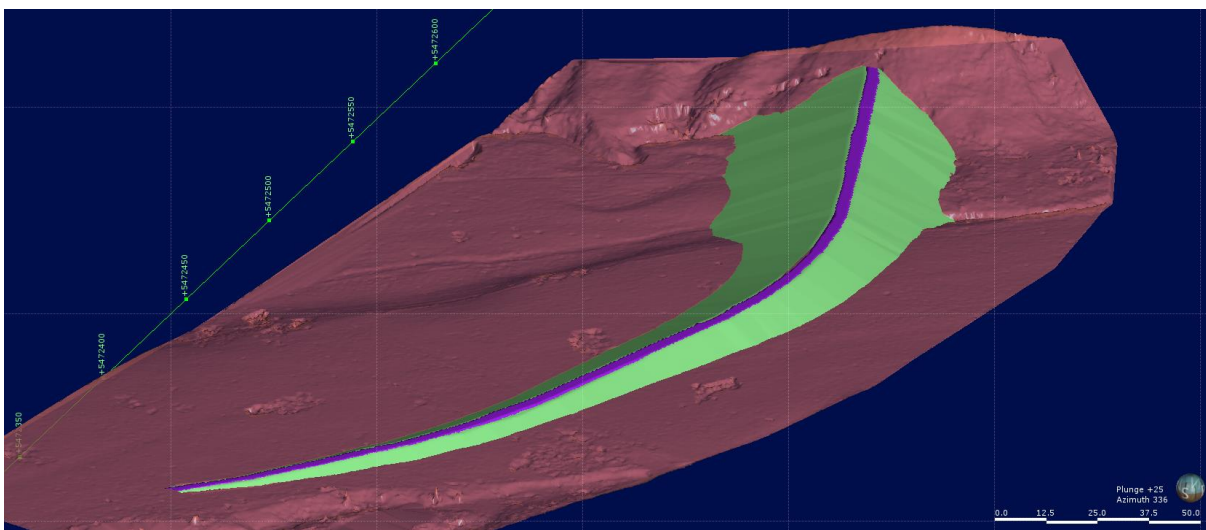

Figure 1. Leapfrog® model of zoned earth fill dam with reservoir area to the left of the model.

## 2. Dam properties

The proposed dam comprises a low permeability core, with upstream and downstream shells with higher permeability. The dam would be built with local soils borrowed from the reservoir area.

Mohr Coulomb shear strengths used for analysis are core  $c=20\text{kPa}$ ,  $\phi=25^\circ$ , downstream and upstream shell  $c=10\text{kPa}$ ,  $\phi=25^\circ$

## 3. TSLOPE model

The surfaces modelled in Leapfrog® were exported as .obj files for loading in TSLOPE. The composite surface comprising the ground upstream of the dam, the face of the upstream shell, the dam crest, the face of the downstream shell, and the ground downstream of the dam was loaded as a Top Surface. Four layers were exported as .obj files and loaded into TSLOPE as Layers.

An educated guess at a phreatic surface was also loaded into TSLOPE.

After assigning material properties to each of the layers, the TSLOPE menu tree was as shown:

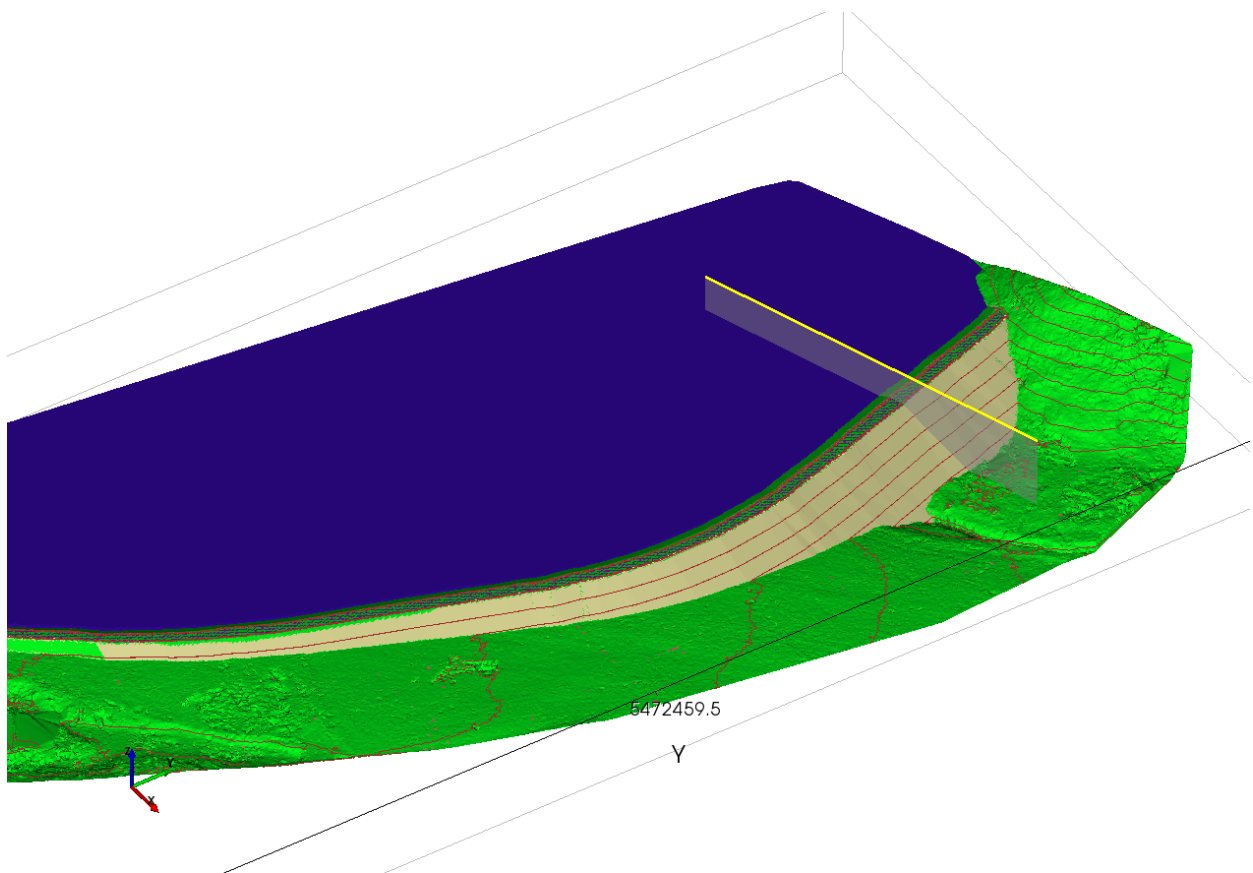
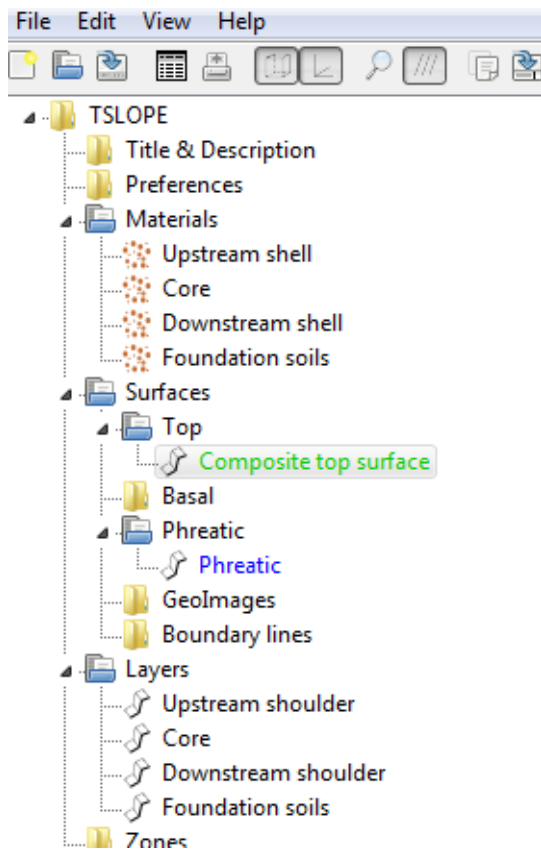

Figure 2. TSLOPE model of dam with reservoir, showing plane of cross section.

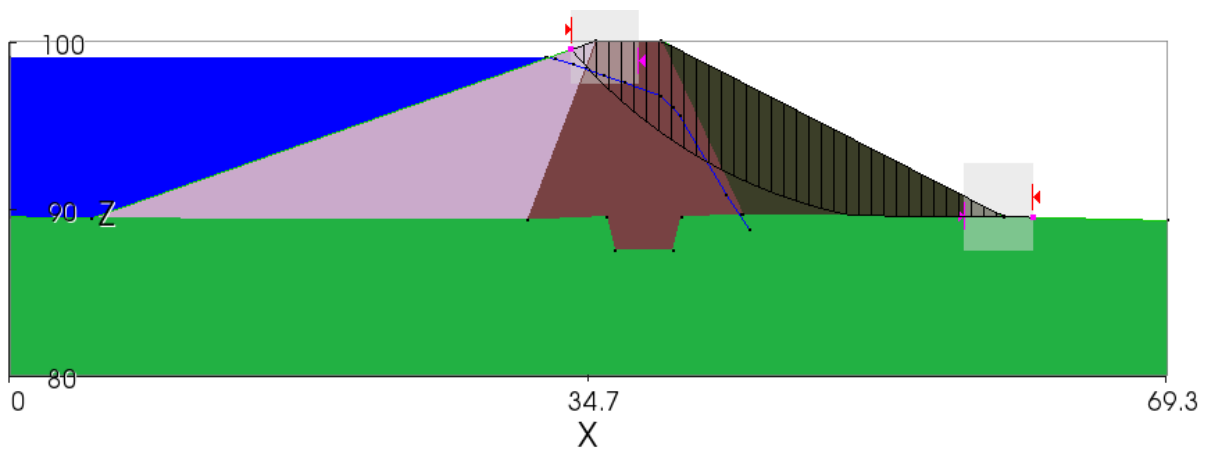

Figure 3. Cross section through dam showing equal spaced slices used in analysis.

#### 4. 2D slope stability analyses

TSLOPE offers users two methods of analysis; the Ordinary Method of Columns (OMC), analogous to the ordinary Method of Slices in 2D, and Spencer's Method. The pros and cons of these two methods will be discussed elsewhere on this site but a potential disadvantage of Spencer's Method and all other methods that "fully satisfy equilibrium" include the generation of tension within the potential sliding mass and a line of thrust that sometimes goes outside the potential sliding mass. After initial runs using Spencer's Method showed significant tension and an unacceptable line of thrust, by trial and error an appropriate depth for a tension crack was established to make the analysis work. Then, using Spencer's Method, and a search routine to find the critical circular failure surface limited by the excavation surface and the tension crack, we obtained the result shown in Figure 4. Note that the line of thrust (red line) is now contained within the potential sliding mass.

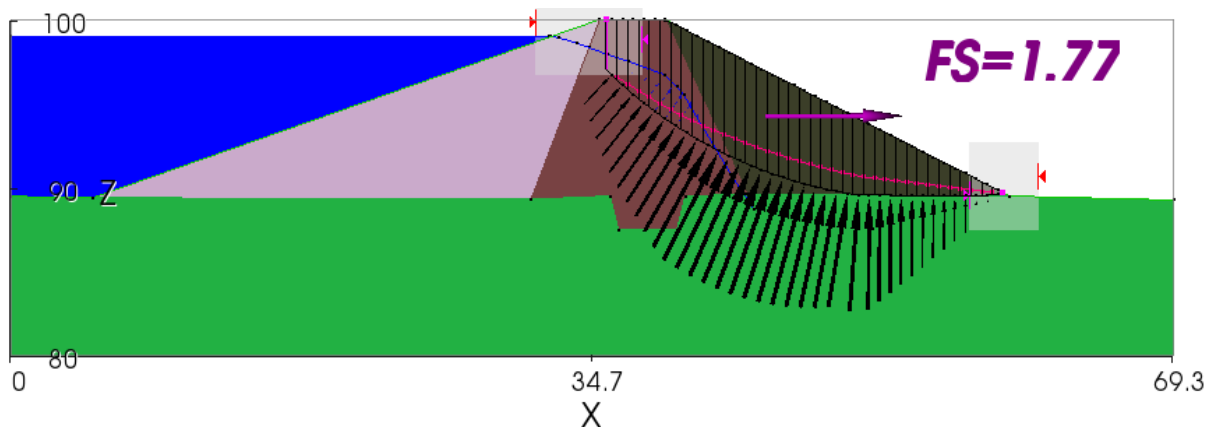

Figure 4. 2D slope stability analysis – Spencer's Method

The same 2D model was analysed using the OMC, with results shown on Figure 5. The OMC is generally more robust than Spencer’s Method and, because of the way the factor of safety is defined, while the two methods give the same factor of safety when the factor of safety is 1.0, the OMC tends to give lower numbers as the factor of safety increases. (As will be explained elsewhere on this site, early criticism of the 2D Ordinary Method of Slices appears to have been largely based on errors in the otherwise excellent 1967 paper by Whitman and Bailey.) The OMC also automatically includes the seepage forces that result from the falling phreatic surface. Methods that “fully satisfy equilibrium” cannot include such forces.

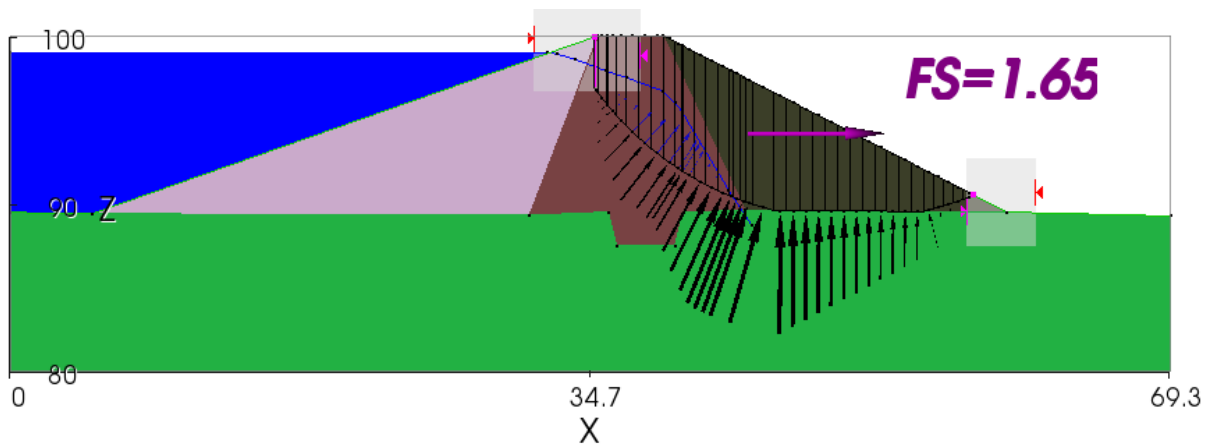

Figure 5. 2D slope stability analysis – Ordinary Method

### 5. 3D slope stability analyses

The critical circle shown in Figure 4 is the 2D projection of a spherical surface that we can use for a comparable 3D analysis.

This circle is shown on Figure 5.

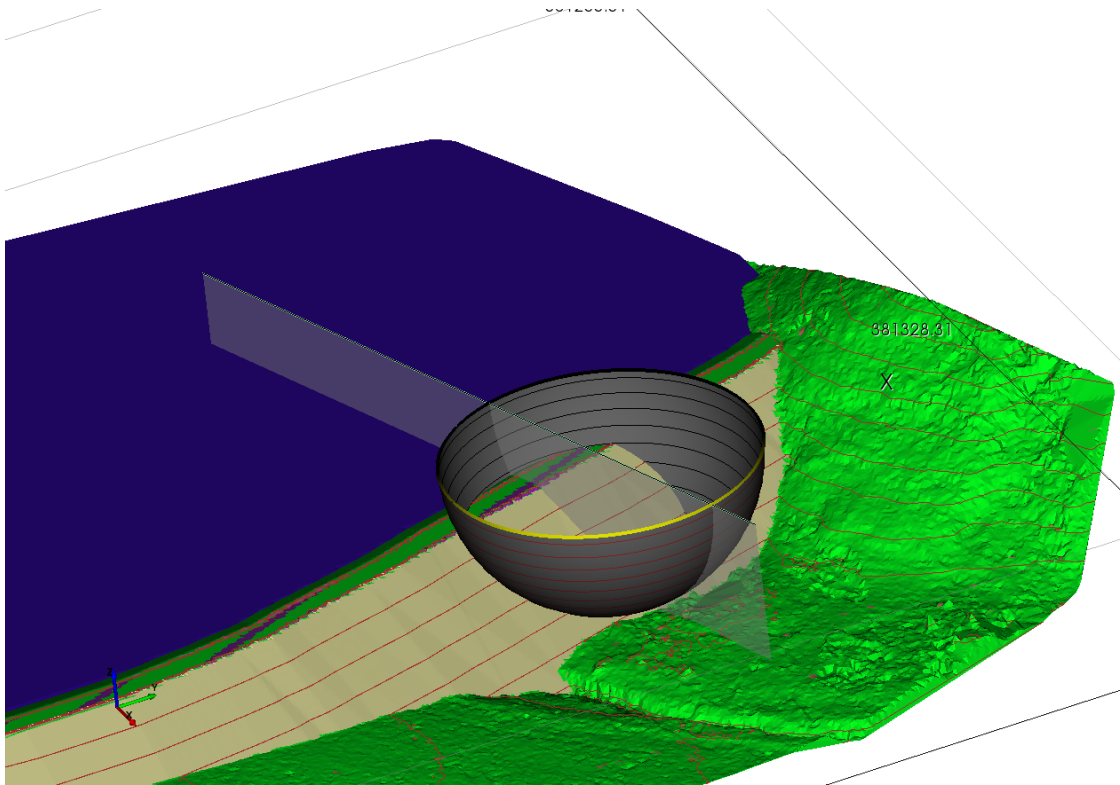

Figure 5. 3D spherical surface equivalent to the 2D critical circle

For this project, we have investigated the change in calculated factor of safety with change in the aspect ratio as we move from a sphere to an ellipsoid, keeping the major axis constant.

For the spherical failure surface, we calculated the following result:

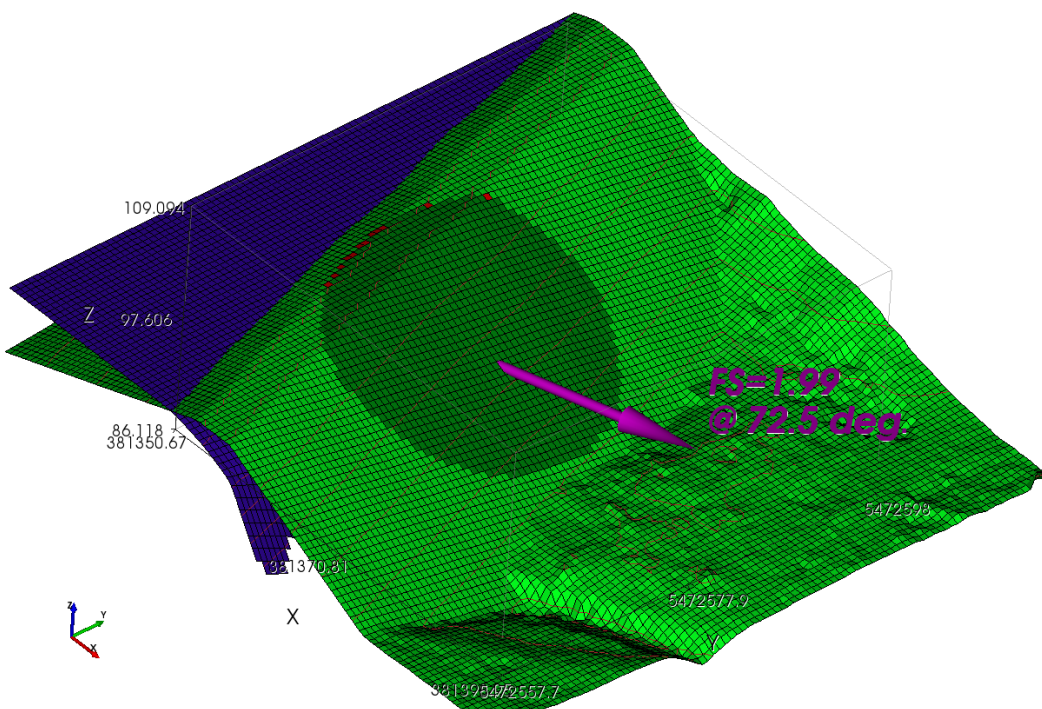

Figure 6. Spherical failure surface, Spencer's Method

The failure surface was altered to an ellipse, with the axis ratio 2:1. We calculated the following result:

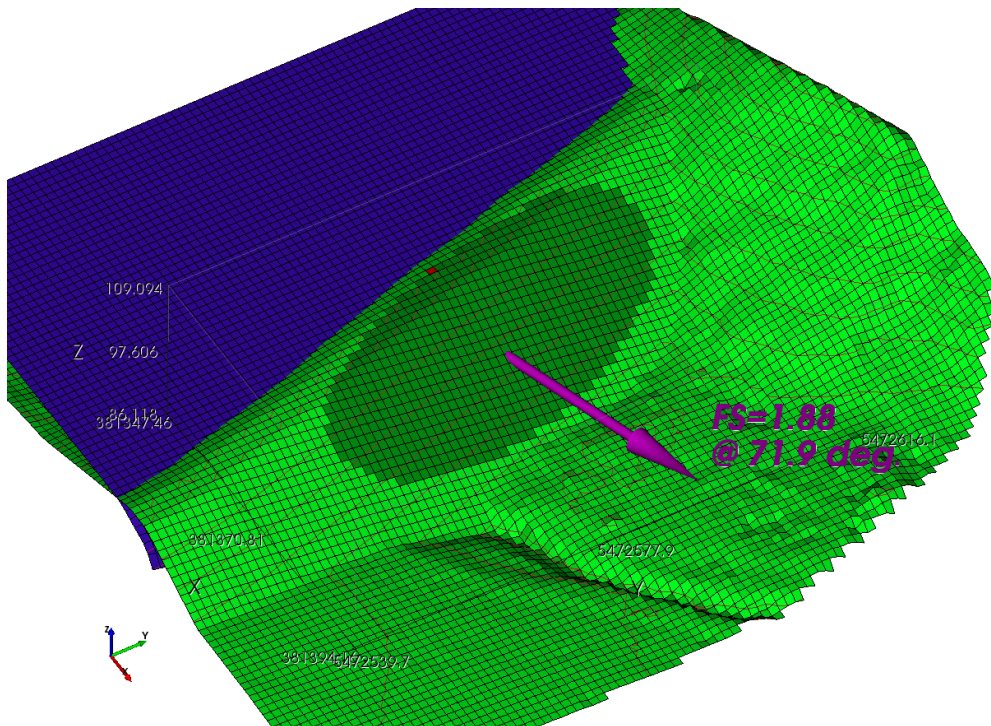

Figure 7. Ellipsoid failure surface (axis ratio 2:1), Spencer's Method

With a narrow ellipsoid (axis ratio 0.5:1), we calculated the following result:

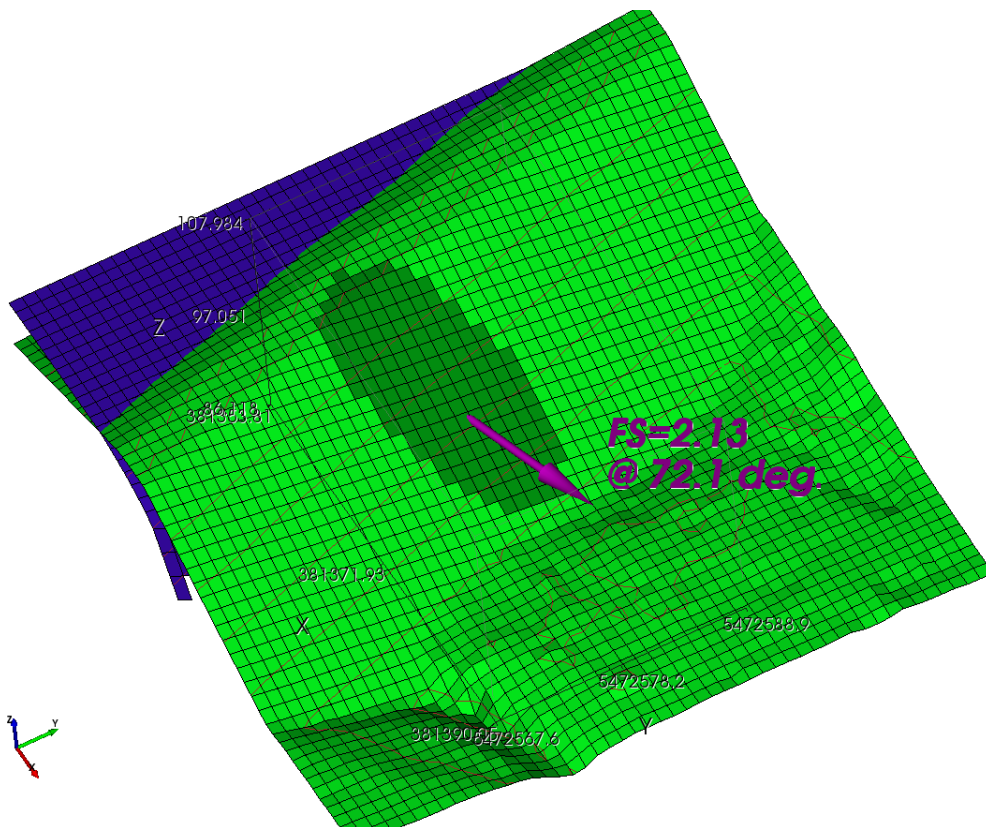

Figure 8. Ellipsoid failure surface (axis ratio 0.5:1), Spencer's Method

In summary, the calculated Factors of Safety are given in the table below:

	Failure shape	Factor of Safety
2D	circle	1.77
3D	2:1 ellipsoid	1.88
3D	Spherical	1.99
3D	0.5:1 ellipsoid	2.13

## 6. Discussion

Factors of safety computed by TSSLOPE for 3D slope cases can be greater or less than those computed for 2D slope cases. It depends on the slope geometry. For this zoned earth fill dam, we have shown that the 2D result is conservative when compared with equivalent 3D analyses.

This is due to the area of the failure surface that comprises dam core relative to the area of the failure surface comprising downstream shell material. Using the Ordinary Method of Columns we are able to plot the local factors of safety at the base of each column, a feature that also warns the user of potential progressive failure (Figure 9). The columns with factors of safety less than one contribute driving forces, while columns with factors of safety greater than one provide resisting forces.

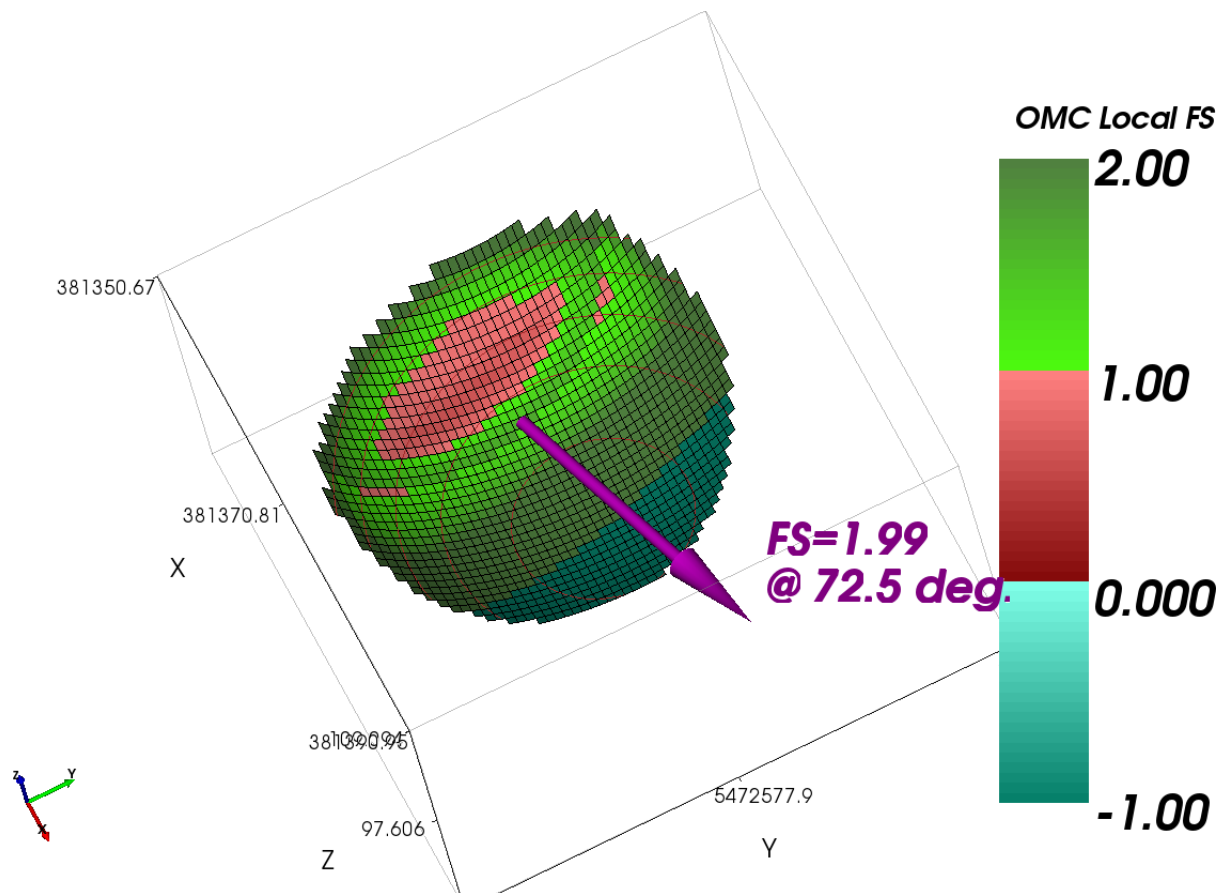

Figure 9. Local Factors of Safety calculated using Ordinary Method of Columns, spherical failure surface

This can be compared with the equivalent plot for the 0.5:1 ellipsoid (Figure 10).

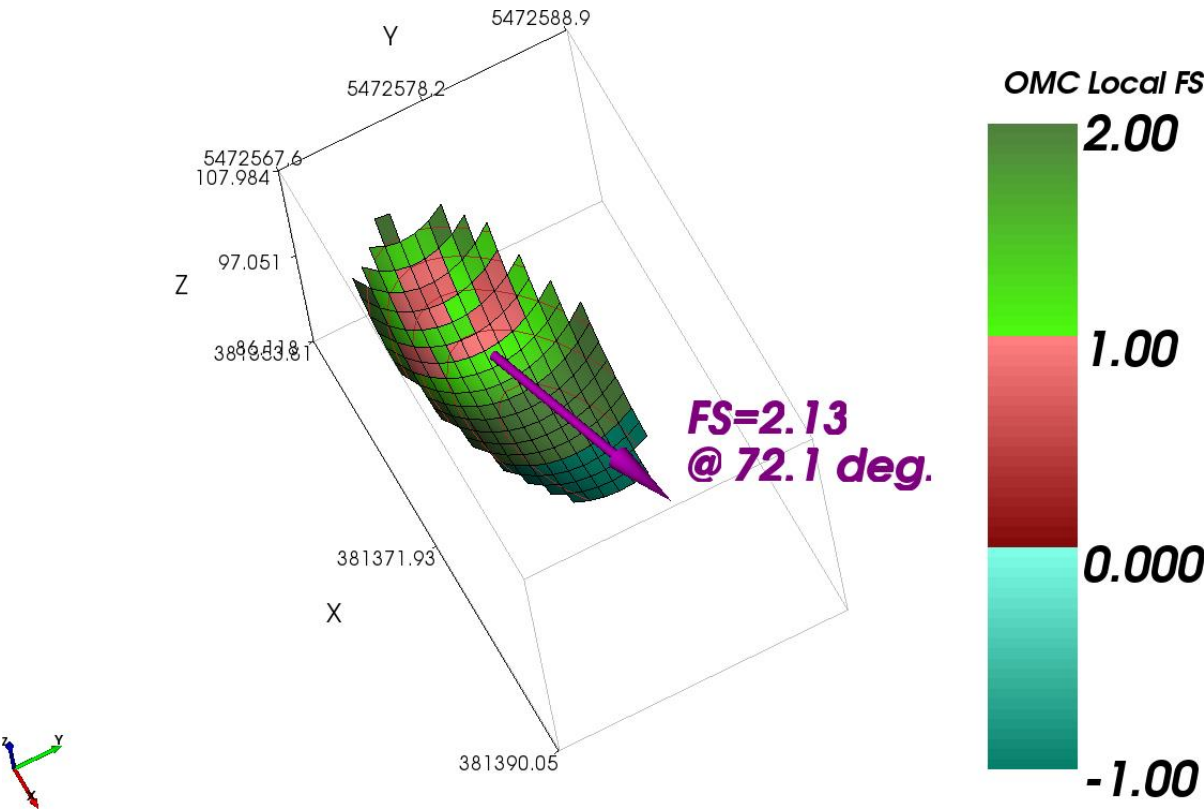

Figure 10 Local Factors of Safety calculated using Ordinary Method of Columns, 0.5:1 ellipsoid failure surface

**7. Conclusions**

It has always been assumed that a dam with a reasonably long axis that takes the abutments out of play, can be analysed using a 2D cross section. This is generally conservative because the core will be weaker than the shells. However, if you want to know the degree of conservatism, you need to run a 3D analysis. While back-calculation of shear strength in 2D analyses can probably be used in forward 2D analyses, the back-calculated strength may be inconsistent with field and laboratory measured values of shear strengths. Where the 3D factor of safety is more than 5 or 10 percent different from the 2D factor of safety, we recommend that 3D analyses are used to develop a consistent overall picture.